

Please read and save this manual. Read carefully before attempting to assemble, install, operate or maintain the product described.

Protect yourself and others by observing all safety information. Failure to comply with manual could result in personal injury and/or property damage! Retain manual for future reference.

WELTEM Water-cooled split portable Air Conditioner

ICEN

Features

Weltem WSC-4000 / WSC-6000 are designed for a fast installation and start up. They can be used usefully where access to the outside is difficult and some distance from internal rooms because outdoor unit (heat exchanger) can be placed up to 30 meters. They are economical units which does not need providing of the water continuously. Quiet in operation enables them to be used in general offices as well. With their durable metal construction and 4 wheels, they are very useful for rental. They are space-efficient because they don't need to have hot air exhaust duct. A control panel provides ease of use and contains a self-diagnostic function.

Choice of continuous operation or automatic timer.



WSC-4000 / WSC-6000

Figure 1

Typical uses

Computer server rooms, Tents, Offices, Events Marquees, Warehouses, Military uses, Commercial kitchens, Hospitals, Schools, Reception areas

Specifications

Model	Cooling Capacity	Refrigerant	Electrical supply	Recommended Fuse Size(MCCB)	Operating range
WSC-4000	16,000BTU (4.7Kw)	R410A (0.90kg)	230V, 1phase, 50hz	15A	18~50°C
WSC-6000	22,000BTU (6.5Kw)	R410A (0.86kg)	230V, 1phase, 50hz	15A	18~50°C

Model	Depth/Width/Height/Weight (Indoor unit)	Depth/Width/Height/Weight (outdoor unit)	Fan speeds	Air flow (high/low)	Noise level at 3m (Indoor unit, high/low)	Control
WSC-4000	705 / 350 / 865mm / 91kg	565 / 275 / 405mm / 24kg	2	780 / 700 m ³ /h	56 / 52 dBA	Electronic
WSC-6000	705 / 350 / 865mm / 95kg	665 / 275 / 455mm / 24kg	2	1020 / 800 m ³ /h	58 / 54 dBA	Electronic

NOTE: Refrigerant and Electrical supply can be different per country. Please check the label on the unit for proper information.

General Safety Information

Please read this manual carefully for instructions on correct installation and usage. Please read all safeguards.

1. Transport and store the unit in an upright position only. Leave unit in an upright position for at least 3 hours before first use.
2. Always place the unit on an even, level surface.
3. Ensure the unit is connected to a grounded power supply of the correct rating / capacity.
4. The unit will cool when the room temperature is between 18°C (64.4°F) ~ 50°C(122°F) depending on the thermostat setting.
5. DO NOT use this unit for functions other than those described in this instruction manual.
6. DO NOT tilt the unit.
7. DO NOT cover or obstruct the unit's inlet and outlet grilles.
8. DO NOT use the unit in areas where it will be exposed to rain or water.
9. NEVER unplug the unit while it is operating.

▲ WARNING *DO NOT use the unit in wet environments, such as a laundry room, to avoid the risk of electrical shock.*

10. DO NOT place any foreign objects on the unit.
11. DO NOT operate the unit with wet or damp hands.
12. DO NOT allow chemical substances to come into contact with the unit.
13. DO NOT operate the unit in the presence of flammable substances or vapors such as alcohols, pesticides, gasoline, etc.

▲ WARNING *DO NOT operate the unit in explosive or flammable environments.*

14. DO NOT use the plug to start and to stop the unit. Always use the control panel to start and to stop the unit.
15. Always turn off the unit when it is not in use and unplug the power plug from the electrical outlet.
16. Always turn the unit off and unplug the main power plug from the electrical outlet before cleaning, moving or performing maintenance.
17. AVOID the use of adapter plugs or extension cords. If it is necessary to use an extension cord or an adapter plug to operate the unit, ensure that they are correctly rated for the application. Consult a local qualified electrician and all local electrical codes to ensure proper setup. Any extension cord used with this device must be rated for a minimum of 15A.
18. DO NOT unplug the unit by pulling on the electrical cord. Keep electrical cord away from heat sources and always completely unroll the cord to avoid overheating. If the power cord becomes damaged, a qualified service agent, qualified electrician, or similarly qualified person must replace it, in order to avoid a hazard or shock.

▲ WARNING *DO NOT operate a unit with a damaged power cord.*

19. The filters must be used with the product at all times. When the filters are removed for cleaning, always ensure that the unit has been turned off and unplugged from the electrical outlet.
20. Regularly clean the filters to maintain efficiency. If the filters are not cleaned regularly, the units output performance and efficiency will decline and energy consumption will increase.
21. DO NOT operate the unit with a damaged power cord or plug, after it malfunctions, has been dropped or damaged.
22. Only use in the upright position on an even, flat surface. Unit must be positioned at least 24 inches (60 cm) from the nearest object in front.
23. Stop operation immediately if abnormal noise or odor is noticed. Contact a local service center.
24. Appliance is not to be used by children or persons with reduced physical, sensory or mental capabilities, or lack of experience and knowledge, unless they have been given supervision or instruction.
25. Children being supervised not to play with appliance.
26. That the appliance shall be installed in accordance with national wiring regulations.
27. If the supply cord is damaged, it must be replaced by the manufacturer, its service agent or similarly qualified persons in order to avoid a hazard.

SAVE THESE INSTRUCTIONS

Assembly
COMPONENT PARTS

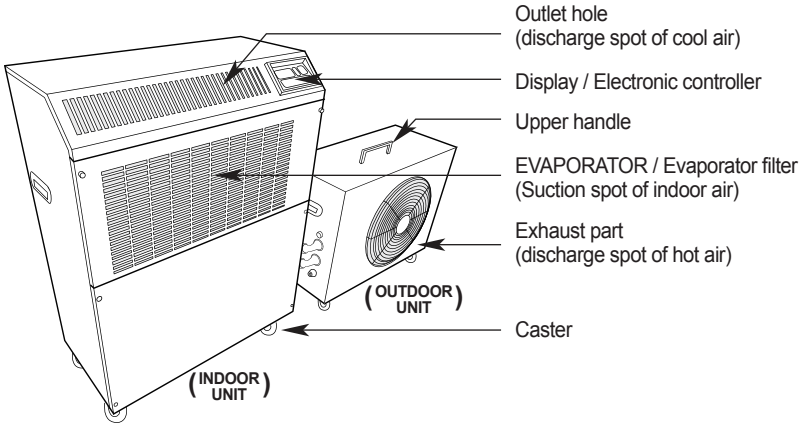

Figure 2
Front and Left Side View

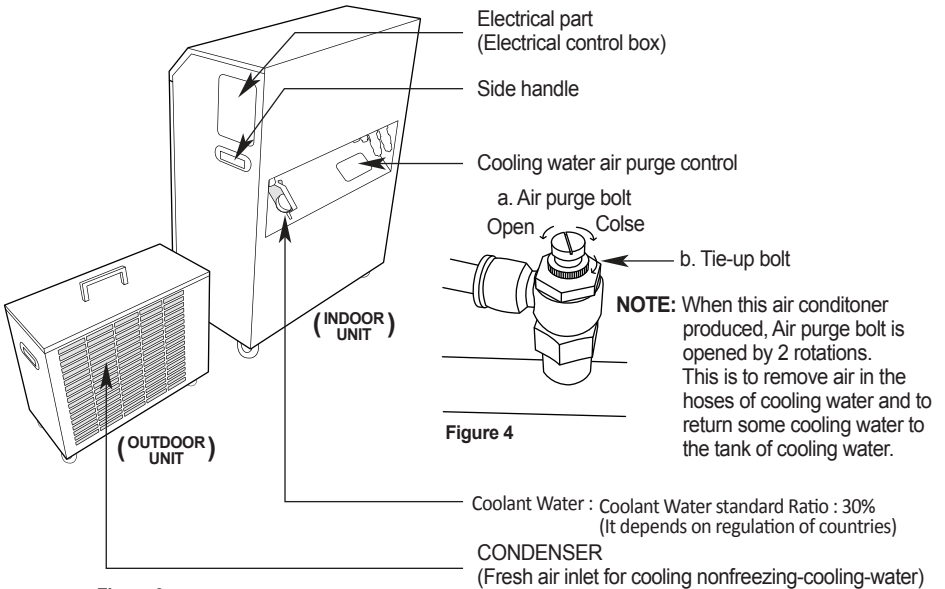

Figure 3
Back and Right Side View

Assembly(Continued)

HOW TO CONNECT THE LINES BETWEEN INDOOR UNIT AND OUTDOOR UNIT

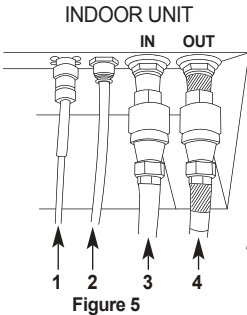

Figure 5

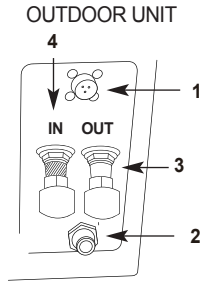

Figure 6

Connect between the same numbers.

1. Power cord : To supply power to the outdoor unit.
2. Drain hose : To drain condensate to the outside.
3. Cooling water line and coupling (Cool water)
4. Cooling water line and coupling (Hot water)

NOTE: Cooling water lines are 5 meters or 10 meters in length. please check with the shop you bought this unit.

Installation

WARNINGS REGARDING PROPER LOCATION FOR INSTALLATION

▲ WARNING *Do not use the unit in explosive environments or in areas where flammable gas leakage may occur.*

▲ WARNING *Do not use the Indoor unit in areas where it will be exposed to rain or water.*

▲ WARNING *Do not use the unit in a corrosive atmosphere.*

▲ WARNING *Do not use the unit above 18°C(64.4°F) ~ 52°C(125.6°F).*

▲ WARNING *Do not install the unit on uneven or sloping surface. The unit may roll or topple over even if the casters are set to the locked position.*

MOVING THE UNIT

Unlock the casters and push the unit using the side handles to a flat, level surface and set the caster brakes to the locked position.

PLUGGING IN THE UNIT

Check the prongs and surface of the power cord plug for dust/dirt. If dust and/or dirt are present, wipe off with a clean, dry cloth.

Check the power cord, plug and prongs for damage or excess play.

If any damage or excess play is found, contact a qualified repair technician or a qualified electrician to perform replacement or repair of the power cord, plug or prongs.

▲ WARNING *If the power cord or plug is damaged, repair should only be performed by qualified electrical personnel.*

▲ WARNING *Do not connect / disconnect the power cord or attempt to operate buttons with wet hands. This could result in electrical shock.*

NOTE: Make sure the AC outlet is free of dirt, dust, oil, water, or any other foreign material.

Operation

CONTROL PANEL

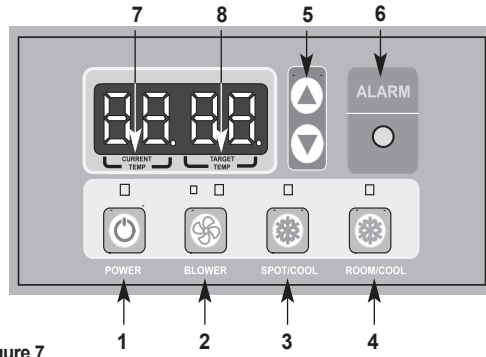

Figure 7

1. **POWER BUTTON:** Activates unit when POWER BUTTON is pressed. (Fan starts on low speed).
If power button is pressed during operation, unit stops.
 2. **BLOWER BUTTON:** Changes fan speed from (Low) to (High) when pressed.
 3. **SPOT/COOL BUTTON:** Activates compressor and begins producing cool air 2 minutes after button is pressed. Regulates temperature based on outlet cool air temperature.
 4. **ROOM/COOL BUTTON:** Activates compressor and produces cool air 2 minutes after button is pressed. Regulates temperature based on inlet ambient air temperature.
 5. **SET TEMP BUTTONS:** Change target temperature/data value by +/- 1. Change data value by +/- 10 by pressing continually.
Press the SET TEMP BUTTONS to set temperature.
Upper button is to heighten temperature and Lower button is to lower temperature.
 6. **ALARM:** Alarm indicator lights (blinks) and indicates abnormal system operation. If Alarm occurs, compressor stops. System operation stops when ALARM light is activated (blinks) longer than 3 minutes.
 7. **CURRENT TEMP:** Displays current room temperature in display in Celsius. (In Room Cool Mode only).
SPOT/COOL Mode – Displays outlet (cool air) temperature during normal operations. ALARM codes blink and are displayed when abnormal operation occurs.
 8. **TARGET TEMP** displays the unit set temperature for ROOMCOOL mode only.
- TIMER:** Enter to Timer setting mode if you press SPOT/COOL button and ROOM/COOL button together for 3 seconds. Press UP/DOWN button to set the timer until it shows the figure you want to set. After 3 seconds, the figure will be memorized and compressor will stop after the time set.

Maintenance

FILTER CLEANING

(See Figures 8 and 9)

There is 1 evaporator filter in front of the unit.

1. loosen up 2 bolts on the front filter guard.
2. Slide filter up and use a vacuum cleaner to remove the dust from the filter.
3. If the filter is heavily covered with dust and dirt, warm water and mild soap or neutral detergent may be used to wash the filter. Do not use any other chemicals to clean filter, as they will likely damage the filter.
4. Dry the filter in a shaded area before replacing it. Do not operate the unit without the filter installed and the filter guard in the closed position.
5. Replace the clean filter and close the filter guard.

NOTE: For effective cooling clean the filter at least every 2 weeks.

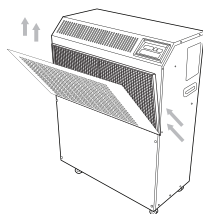
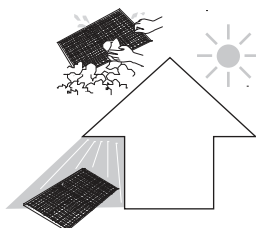

Figure 8 – Removing Filter



- Remove dust from the filter using a vacuum cleaner hose attachment.
- If required wash the filter in lukewarm water with a mild detergent. Leave to dry in a shaded area before reinstalling.

Figure 9 – Removal of Dust

▲ WARNING Do not operate without the filter fitted.

▲ WARNING Do not operate the unit with a damaged cord or plug, after the unit malfunctions, or if the unit has been dropped or damaged.

- For your convenience, record the complete model number and product name (located on the Product Identification Plate), the purchase date, purchase location, serial number, and warranty period in the table below.
- Also, attach your purchase receipt as proof of purchase to this instruction manual for future reference.
- To ensure your product is covered by warranty, the complete faulty product along with your original purchase receipt must be provided at the place of purchase.

Product	Water - cooled split Portable Air Conditioner
Model No.	_____
Date of Purchase	_____
Place of Purchase	_____
Serial No.	_____
Period of Warranty	_____

Customer: Please read and keep this manual for future reference and keep sales receipt as proof of purchase.

SELF-DIAGNOSTIC CODES

(See Table 1)

The alarm light is activated if abnormal operation occurs, and a code is displayed on the control panel. The compressor and condenser fan motor will stop operating. The evaporator fan will continue to run for 3 minutes. If the fault is rectified within 3 minutes, the unit will resume operation. If the fault persists for more than 3 minutes, the evaporator fan also stops. The fault must be rectified before the unit can resume normal operation.







SELF-DIAGNOSTIC CODES			
Alarm Display	Problem	Cause	Corrective Action
	Frost prevention sensor and Abnormal temperature sensor value	<ul style="list-style-type: none"> a. Indoor heat exchanger temperature too low b. TH3 temperature sensor has a loose or broken connection 	<ul style="list-style-type: none"> a. Do not use the air conditioner if ambient temperature is lower than 18°C (64°F) b. Contact a qualified service agent
	Refrigerant high pressure switch	<ul style="list-style-type: none"> a. Blocked air filter b. Ambient temperature is too high c. Cooling pump is not operate normally d. Power is not supplied to outdoor unit 	<ul style="list-style-type: none"> a. Clean air filter b. Do not use the air conditioner if ambient temperature is higher than 52°C(125.6°F) c. Check Cooling pump is operating normally. Check the cooling water line between indoor and outdoor unit is folded. d. Connect power cord between indoor unit and outdoor unit <p>Contact service center if porblem persists</p>
	Abnormal temperature sensor value	TH1 outlet temperature sensor has a loose or broken connection	Contact service center
	Abnormal temperature sensor value	TH2 inlet temperature sensor has a loose or broken connection	Contact service center
	Compressor overloaded	<ul style="list-style-type: none"> a. Ambient temperature is too high b. Unstable voltage supply c. Defective compressor 	<ul style="list-style-type: none"> a. Do not use the air conditioner if ambient temperature is higher than 52°C(125.6°F) b. Contact service center if problem persists. c. Replace compressor
	Condensate water level alarm	Drain of condensate water is not working well.	<ul style="list-style-type: none"> a. Turn off and on the unit. b. Check if drain of condensate water is working well.

Table 1 – Alarm Codes

Wiring Diagram

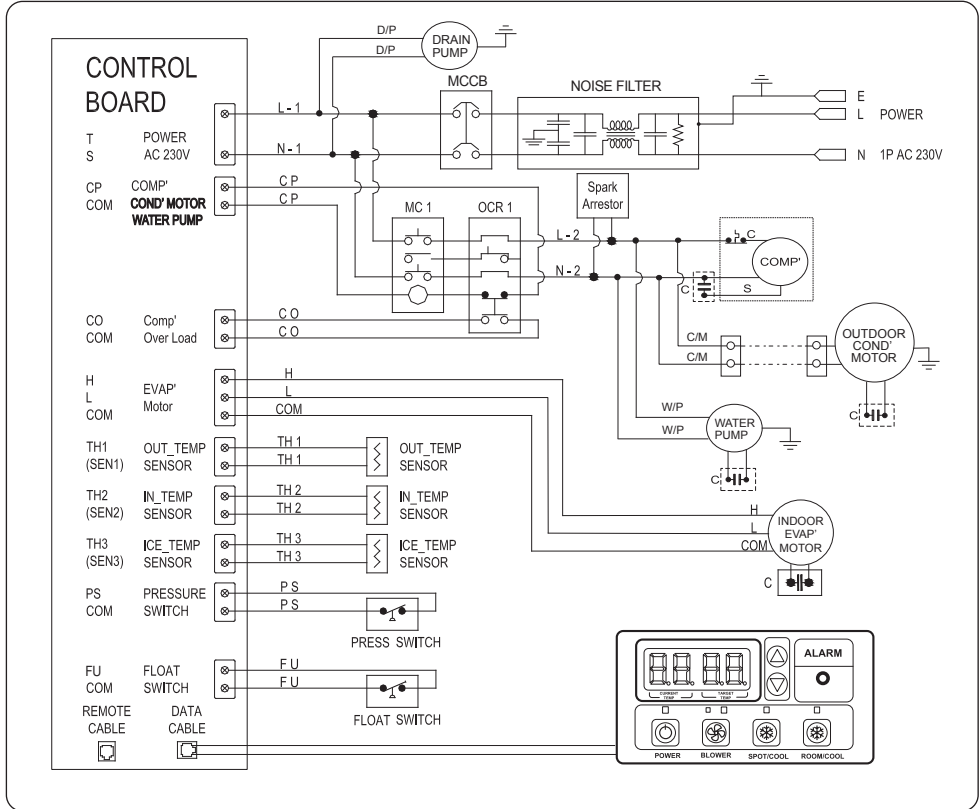

Figure 10 - Circuit Wiring Diagram

Troubleshooting chart

Symptom	Possible Cause(s)	Corrective Action
No air flow from the indoor unit	<ol style="list-style-type: none"> 1. Check the power supply to verify that power is available to the unit. 2. Verify that the power cord is connected. 	<ol style="list-style-type: none"> 1. Reset the circuit breaker and restart the unit. 2. Connect power cord.
Insufficient air flow from the indoor unit	Blocked air filter	Clean filter
Air from the room unit is not cool	<ol style="list-style-type: none"> 1. Only BLOWER light on. ROOM/COOL and SPOT/COOL light off 2. Compressor will start in 2 minutes after unit is restarting 3. The ambient temperature may be too high 	<ol style="list-style-type: none"> 1. Press ROOM/COOL button or SPOT/COOL button 2. Verify that 2 minutes has passed since the unit restarted. 3. The temperature of the compressor can be higher when the ambient temperature is too high. The compressor will not work unless the ambient air temperature is within the acceptable operating range of the unit.
Abnormal noise from the pump	Cooling water line is not connected properly	Connect cooling water line properly

Notes

Notes

LIMITED WARRANTY

WELTEM ONE-YEAR LIMITED WARRANTY. WELTEM PORTABLE AIR CONDITIONERS, MODELS COVERED IN THIS MANUAL, ARE WARRANTED BY WELTEM TO THE ORIGINAL USER AGAINST DEFECTS IN WORK MANSHIP OR MATERIALS UNDER NORMAL USE FOR ONE YEAR AFTER DATE OF PURCHASE. ANY PART WHICH IS DETERMINED TO BE DEFECTIVE IN MATERIAL OR WORKMANSHIP AND RETURNED TO AN AUTHORIZED SERVICE LOCATION, WELTEM DESIGNATES, SHIPPING COSTS PREPAID, WILL BE, AS THE EXCLUSIVE REMEDY, REPAIRED OR REPLACED BY WELTEM OPTION. FOR LIMITED WARRANTY CLAIM PROCEDURES, SEE "PROMPT DISPOSITION" BELOW. THIS LIMITED WARRANTY GIVE PURCHASERS SPECIFIC LEGAL RIGHTS WHICH VARY FROM JURISDICTION TO JURISDICTION.

LIMITATION OF LIABILITY. TO THE EXTENT ALLOWABLE UNDER APPLICABLE LAW, WELTEM LIABILITY FOR CONSEQUENTIAL AND INCIDENTAL DAMAGES IS EXPRESSLY DISCLAIMED. WELTEM LIABILITY IN ALL EVENTS IS LIMITED TO AND SHALL NOT EXCEED THE PURCHASE PRICE PAID.

WARRANTY DISCLAIMER. A DILIGENT EFFORT HAS BEEN MADE TO PROVIDE PRODUCT INFORMATION AND ILLUSTRATE THE PRODUCTS IN THIS LITERATURE ACCURATELY; HOWEVER, SUCH INFORMATION AND ILLUSTRATIONS ARE FOR THE SOLE PURPOSE OF IDENTIFICATION, AND DO NOT EXPRESS OR IMPLY A WARRANTY THAT THE PRODUCTS ARE MERCHANTABLE, OR FIT FOR PARTICULAR PURPOSE, OR THAT THE PRODUCTS WILL NECESSARILY CONFORM TO THE ILLUSTRATIONS OR DESCRIPTIONS. EXCEPT AS PROVIDED BELOW, NO WARRANTY OF AFFIRMATION OF FACT, EXPRESSED OR IMPLIED, OTHER THAT AS STATED IN THE "LIMITED WARRANTY" ABOVE IS MADE OR AUTHORIZED BY WELTEM.

Technical Advice and Recommendations, Disclaimer. Notwithstanding any past practice or dealings or trade custom, sales shall not include the furnishing of technical advice or assistance or system design. Weltem assumes no obligations or liability on account of any unauthorized recommendations, opinions or advice as to the choice, installation or use of products.

Product Suitability. Many jurisdictions have codes and regulations governing sales, construction, installation, and/or use of products for certain purposes, which may vary from those in neighboring areas. While attempts are made to assure that Weltem products comply with such codes, Weltem cannot guarantee compliance, and cannot be responsible for how the product is installed or used. Before purchase and use of a product, review the product applications, and all applicable national and local codes and regulations, and be sure that the product, installation, and use will comply with them.

Certain aspects of disclaimers are not applicable to consumer products; e.g., (a) some jurisdictions do not allow the exclusion or limitation of incidental or consequential damages, so the above limitation or exclusion may not apply to you; (b) also, some jurisdictions do not allow a limitation on how long an implied warranty lasts, consequently the above limitation may not apply to you; and (c) by law, during the period of this Limited Warranty, any implied warranties of implied merchantability or fitness for a particular purpose applicable to consumer products purchased by consumers, may not be excluded or otherwise disclaimed.

Prompt Disposition. A good faith effort will be made for prompt correction or other adjustment with the respect to any product which proves to be defective within limited warranty. For any product believed to be defective within limited warranty, first write or call dealer from whom the product was purchased. Dealer will give additional directions. If unable to resolve satisfactorily, write to Weltem at the address below, giving dealer's name, address, date, and number of dealer's invoice, and describing the nature of the defect. Title and risk of loss pass to buyer on delivery to common carrier. If product was damaged in transit to you, file claim with carrier.

Manufactured in Weltem co., Ltd., 118, Jayumyeok 3-gil, Masanhoewon-gu, Changwon-City,
Gyeongsangnam-do, 51340 Korea
www.weltem.com

Printed in July, 2016